



## Texecom Connect Guide

INS760



## 1. Introduction

Texcom's Premier Elite Series is the perfect security system for modern connected homes and buildings.

Texcom's Premier Elite Series provides a single, comprehensive system architecture and peripheral range that scales from the simplest and smallest security applications through to the largest and most complex.

Featuring a common programming platform, interoperable wired and wireless peripheral devices, design flexibility and integration capabilities, the Premier Elite Series provides a high performance security solution for applications around the world.

Texcom's new connectivity platform, Texcom Connect, allows security installers to deliver enhanced smart solutions for both commercial and residential customers without compromising on core security principles. Texcom Connect enables a wide range of applications to be supported, adding significant value to alarm systems.

With Texcom Connect, security installers are able to offer customers a secure system with the additional benefits of automation, smart management and flexible control, all from the established and familiar Premier Elite range of control panels.

The Texcom Connect concept is a very simple one. At its heart is a professional quality graded intruder alarm system that uses the proven Premier Elite range of control panels. Along with the intruder alarm system, security installers can offer a more immersive experience for the customer, allowing them to take control of the system, along with other peripherals such as video, lighting, heating, power management and smart control of household appliances.

Texcom Connect is compatible with all Premier Elite control panels; older panels may be upgraded to add connect functionality to existing Premier Elite alarm systems. Texcom Connect enhances Premier Elite alarm systems with the addition of an app, smart communicator and API. Together these allow end users to engage with their intruder alarm solutions in an intuitive and flexible way, ensuring that advanced security, building control and site automation can all be managed easily and securely from any connected and authorised smartphone or tablet device.

For end users, Texcom Connect completely transforms the end user experience. The Texcom Connect App provides an environment where end users actively want to interact with their home, enjoy the new possibilities that are open to them, and delivers the piece of mind that comes with knowledge and control.

Texcom Connect uses technology to make people's lives easier, not more complex. The Texcom Connect App has been carefully designed to allow end users access to an array of custom features, to tailor their app experience for their own personal and particular needs, without resorting to complicated programming.

For security installers, Texcom Connect ensures that whilst smart functionality can be added to increase the value of the system, this does not impact on, nor compromise, the performance of the graded professional intruder alarm systems. All additional functionality – which enables interoperability with security, lighting, heating and power management – is managed by the Premier Elite control panel, so there is no risk of secondary tasks adversely affecting the system's performance.

Texcom Connect introduces a choice of connectivity options to transform the user experience, enabling intruder alarm systems to deliver customer value every day.

<b>Contents</b>	<b>Page</b>
<b>1. Introduction</b>	<b>2</b>
<b>2. Contents</b>	<b>3</b>
<b>3. System Requirements</b>	<b>4</b>
<b>4. Network Requirements</b>	<b>4</b>
<b>5. Texecom Connect System</b>	<b>5</b>
<b>6. Texecom Connect Components</b>	<b>6</b>
<b>7. System Requirements</b>	<b>7</b>
<b>8. Installation Steps</b>	<b>8</b>
<b>9. SmartCom Opening &amp; Identification</b>	<b>8</b>
<b>10. Connecting to The Panel</b>	<b>9</b>
<b>11. Ethernet Connection</b>	<b>10</b>
<b>12. WiFi Connection</b>	<b>10</b>
<b>13. PROGRAMMING THE PANEL</b>	<b>11</b>
<b>14. ComPort Set Up &amp; UDL Password</b>	<b>12</b>
<b>15. Configure Panel for Texecom Connect</b>	<b>15</b>
<b>16. Enable Texecom Connect App</b>	<b>17</b>
<b>17. Setting Up the Texecom Connect App</b>	<b>19</b>
<b>18. Connect Devices</b>	<b>34</b>
<b>19. Appendix A - Flash Upgrading an Elite Panels</b>	<b>35</b>
<b>20. Appendix B - Power up and Initial Config Upgrade Panels</b>	<b>39</b>
<b>21. Troubleshooting</b>	<b>42</b>
<b>22. Specifications</b>	<b>43</b>

### 3. System Requirements

To setup a Texecom Connect™ system you will need the following as a bare minimum:

- A Texecom Premier Elite security system with V4 or later firmware installed.
- Texecom Connect App (iOS) —iPhone, iPad and iPod touch running iOS 8.0 or later; certain features may require later versions. Touch the App Store button on your iPhone, iPod touch or iPad to download the free Texecom Connect app, or download the application from iTunes®. (If you download from iTunes, you will need to sync before you see the Connect logo display on your device.)
- SSID & Password for the Network if you intend to connect by WiFi.
- A Texecom Connect SmartCom.
- A laptop or PC with Wintex installed.

In addition if the system will be using any *Ricochet*® enabled devices the wireless receiver should be V3.0.6 or later.

Peripheral products may also be used to enhance the user experience. Some of these are traditional security devices such as Compact wireless PIR's with added functionality such as Light and Temperature reading capability.

Other products designed for specific Home Automation tasks such as the Texecom Connect SmartPlug may also be added to the system. These devices can be added at the time of installation, or if the functionality is enabled may be added and removed as required by the Master User.

### 4. Network Requirements

Texecom Connect needs to be able to communicate with the outside world so that push notifications can be sent to the users device; and so that commands from the device can be sent to the system.

To enable these requirements for WiFi you will need access to the users network SSID & password, which must have a router or router/modem. Modem only systems are not supported.

Texecom Connect will only function on networks with DHCP enabled.

Texecom Connect SmartCom operates at 2.4 GHz supporting 802.11b/802.11g & 802.11n wireless technology.

5GHz networks are not supported.

## 5. Texecom Connect System

The Texecom Connect App is reliant on an existing Texecom security system in order for it to work. Below is an overview of the full Texecom Connect System so you can understand the full ecosystem.

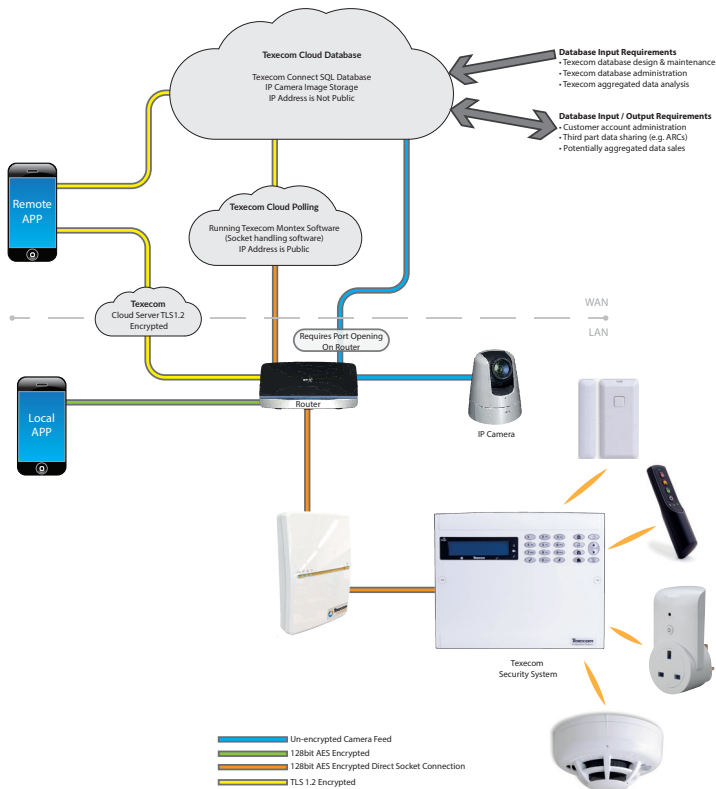

## 6. Texcom Connect Components

### Premier Elite V4 Firmware

The Texcom Connect SmartCom, App, Hub and API all require Premier Elite control panels to run V4 firmware or above. Any legacy Premier Elite control panel can be flash upgraded to the latest firmware. Texcom regularly releases firmware upgrades to enhance performance and provide additional features.



### Texcom Connect SmartCom

The Texcom Connect SmartCom is an intelligent communicator that facilitates the Texcom Connect experience by connecting any Premier Elite control panel to a local area network.

The Texcom Connect SmartCom communicates using outbound connections, removing the need to open any router ports, which ensures simplicity of installation and maximum security.

As such, any installation that has an internet connection can reliably use Texcom Connect with the addition of the Texcom Connect SmartCom.

### Texcom Connect App

The Texcom Connect App is a smartphone app for iOS devices.

Transforming the user experience, the Texcom Connect App adds home automation and end user control to Texcom's Premier Elite range of professional security systems.

Featuring a timeline for direct access to events, direct control over home automation devices, recipes to create home automation effects and pre-set system modes, push notifications of system events and direct camera control.



### Texcom Connect SmartPlug

Take control over your powered devices and control any mains-powered device remotely with the SmartPlug. This *Ricochet* enabled wireless plug sits between a wall socket and the power plug of a device, and is controlled via the Texcom Connect app.

Texcom Connect integrates with Texcom's flagship security systems, the Premier Elite Series, to allow you to take direct control of your home and your security. Control the operation of your security system, receive notifications of system events and monitor cameras or activity from anywhere in the world.

## 7. System Requirements

The following hardware is compatible with the Texecom Connect App.

### Premier Elite Control Panel (live-front, polymer or metal)

- Premier Elite 12
- Premier Elite 12-W
- Premier Elite 24
- Premier Elite 24-W
- Premier Elite 48
- Premier Elite 48-W
- Premier Elite 64-W
- Premier Elite 88
- Premier Elite 168
- Premier Elite 8/32XP-W (for wireless devices - not required on -W panels)

### Communication Module

- Texecom Connect SmartCom
  - CEL-0001 SmartCom (WiFi and Ethernet)
  - CEL-0002 SmartCom (Ethernet)

### Security Devices

#### Texecom Connect Devices

- Texecom Connect SmartPlug

#### IP or WiFi Cameras (optional)

**USB-Com** (only required if connecting either Flasher or Wintex to your panel)

#### Firmware / Software Versions

The following firmware and software versions are required to fully use Texecom Connect App.

#### Premier Elite Control Panel Firmware\* V4.00 >

*\*The control panel firmware can be upgraded using the Premier Elite Flasher Interface. See Appendix A.*

#### Premier Elite 8/32XP-W Firmware V3.06 >

**Wintex V6.2.5** > This may be downloaded from the "Software & Peripherals" page in the "Products" section of the Texecom website ([www.texe.com](http://www.texe.com))

#### Ricochet Monitor V2.18.6 >

**IMPORTANT** - The firmware in the Premier Elite 8 & 32XP-W (or equivalent -W panel) cannot be upgraded in the field. Changing the expander or panel to one that contains expander firmware V3.06> will:-

- Display temperature and light levels from *Ricochet* enabled devices.
- Eliminate delays in response time from Texecom Connect SmartPlug when the SmartPlug is moved from it's initial location to a new one in the property.

Unfortunately, if you already have devices on a wireless system with an earlier version of expander firmware, the only choice will be to re-learn all of the devices onto a new expander if you want the features detailed above.

## 8. Installation Steps

To fully utilise the Texecom Connect App please follow the following steps:-

- Physically install your control panel and security system (*upgrading the control panel firmware if necessary see Appendix A*).
- Configure the control panel and security system.
- Configure the SmartCom
- Setup the Connect App
- Add any Connect devices

## 9. SmartCom Opening & Identification

The Premier Elite SmartCom is an advanced dual Ethernet & WiFi intelligent communicator compatible with all Premier Elite control panels with V4.00 or later firmware installed.

The SmartCom is remotely upgradable enabling new features and functions to be delivered to the device over the air, reducing the need for site visits.

SmartCom enables remote panel connections from Wintex, and the Connect App without requiring router port forwarding.

The SmartCom obtains its IP address by DHCP which must be enabled on the router.

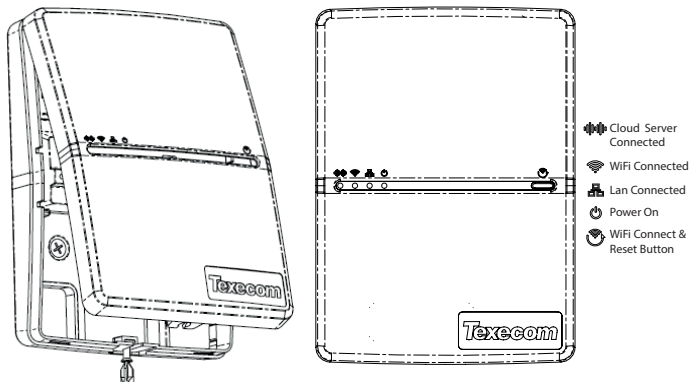



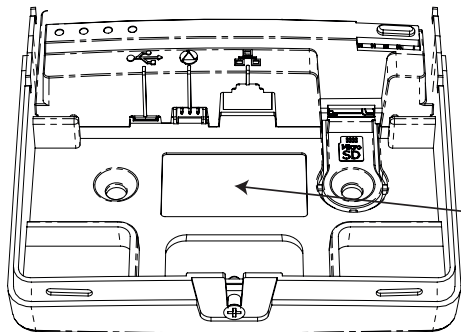

## LED Indications

- The Power LED should be on solid
- The LAN or WiFi LED will be on solid when connected to the network.
- The Cloud LED will be on solid when connected to our servers and all information is correct to enable bi-directional communication.
- If the Cloud LED is flashing, please check that the system is configured correctly. If symptoms persist and the light does not go solid please contact Tech Support.
- When a firmware upgrade is taking place all LED's may flash sporadically, this is normal.





-  Micro USB - for future use
-  Com Port Cables Connection
-  Lan Cable Connection
-  Micro SD slot - for future use
- Label showing SSID & Passphrase

## 10. Connecting to the panel

The SmartCom requires two Com ports on the control panel. The 4 wire connector provides the SmartCom element of the device, the two wire connector provides the ComIP alarm reporting element.

A Premier Elite ComPort+ is provided which may be used to utilise the digi modem connection to provide Com Port 3 on Premier Elite 48/64/88 & 168.

Insert the black connector into the SmartCom. This is normally already inserted.

**Note:** the yellow wire should be on the upper right hand side.

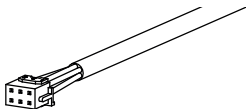

Connect the two white connectors to the Elite panel.

**Note:** Plug the 4 wire connector onto Com Port 1 on the Control Panel. This should be configured as SmartCom.

Plug the 2 wire connector onto Com Port 2 on the Control Panel. This should be configured as Com IP.

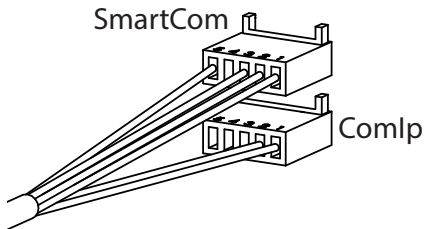

## Connecting to the panel (Continued)

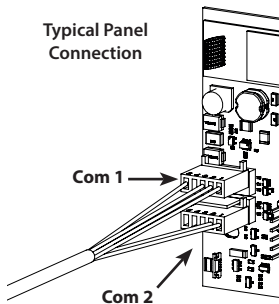
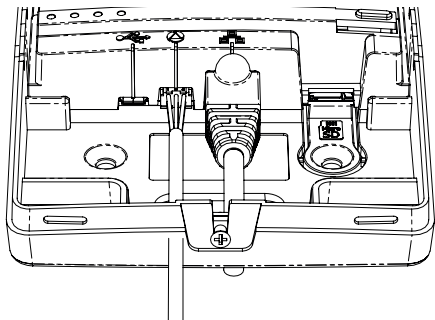

## 11. Ethernet Connection

To operate as an Ethernet Communicator, plug an Ethernet cable into the SmartCom and the other end into a spare LAN port on the router or switch.

You do not need to know any details from the router for the system to work. An IP address will be assigned by DHCP from the router, and programmed into the panel.

IP addresses will only show for the ComIP com port. This is normal and correct.

## 12. WiFi Connection (for SmartCom that supports WiFi Connectivity)

To enable a WiFi connection you will need access to the customers network SSID & password. The SmartCom will only function on networks with DHCP enabled.

The SmartCom operates at 2.4 GHz supporting 802.11b/802.11g & 802.11n wireless technology. 5GHz bands are not supported.

Press and hold the WiFi button for 5 seconds until the WiFi LED starts blinking approximately once per second.

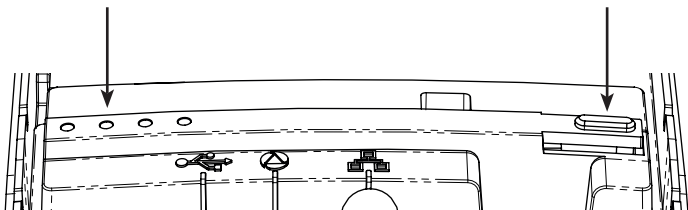

Connect a laptop or tablet to the WiFi SSID that starts “SmartCOM” followed by a number.

**NOTE:** It can take up to 60 secs for the SSID to appear on your device. Please be patient.

Click Connect and enter the passphrase when prompted. The passphrase can be found on the label inside the SmartCom.

Once connected, open a web browser and in the address bar enter 192.168.2.1, then press return or refresh.

A list of available WiFi networks should appear in the browser.

Click the button next to the required connection and enter the WiFi passphrase. (Router password)

Click “Connect”.

The SmartCom will flash the WiFi LED quickly while it connects to the WiFi network. Once the connection is made, the LED will remain on permanently.

The SmartCom is now connected to the WiFi and ready for use.

When connected via WiFi the IP address will be displayed by the panel as 0.0.0.0 this is normal and should not be changed.

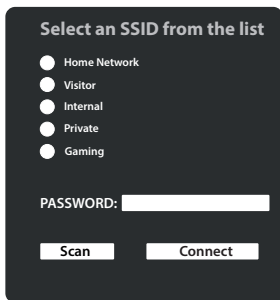

### 13. PROGRAMMING THE PANEL

The next step is to program the panel to communicate with the SmartCom by setting the Com port configuration and the Alarm reporting. Use the  provided to mark progress.

**It should be noted that to function correctly with the Texecom Connect app the following applies:-**

- All Zones MUST have text. Without text the app will not know the zone exists.
- All Areas MUST have text. Without text the app will not know the Areas exist.
- Users of the system MUST have a User Name. Without this the app will not recognise the user.
- A UDL password MUST be programmed
- Flash upgraded panels must have a Unique ID. See page 41 for details.

**Any Texecom Connect devices being used should only be added when all other programming and configuration has taken place.**

**Connect devices MUST be added or removed using the Texecom Connect app, and should only be added when all Ricochet Enabled security or life safety devices are in place.**

## 14. Com Port Setup & UDL Password

Enter the engineers code (1)(2)(3)(4)

```
Yes to Select:-  
Zone Setup
```

Press (7) on the keypad

```
YES to Select:-  
UDL/Digi Options
```

Press (✓)/(Yes)

```
UDL/Digi Options  
Reset Digi
```

Press (8) or (↕) to

```
UDL/Digi Options  
Com Port Setup
```

Press (✓)/(Yes)

```
Onboard Digicom  
Nothing Fitted
```

Press (✓)/(Yes)

```
Com Port 1  
Nothing Fitted
```

Press (X)/(No)



```
Com Port 1
Nothing Fitted <
```

Use the  key to select the SmartCom Module

```
Com Port 1
SmartCom >
```

Press  / 

```
Com Port 1
SmartCom
```

Press  / 

```
Com Port 2
Nothing Fitted
```

Press  / 

```
Com Port 2
Nothing Fitted <
```

Use the  key to select the ComIP Module

```
Com Port 2
ComIP Module <
```

Press  / 



Com Port 2  
ComIP Module

Press  /  2 times

YES to Select:-  
UDL/Digi Options

- A UDL password must be programmed into the panel in order to connect with the app. Continuing from above please follow these steps.

Press  / 

UDL/Digi Options  
Reset Digi

Press  or  to

UDL/Digi Options  
UDL Options

Press  / 

Call Back No. 1:

Press  or  to

UDL Password is:



Press  /  No

^Edit Text >123

Enter a UDL password and press  /  Yes

NOTE - if you have already changed the Engineer code this will already be UDL password.  
You may choose a different UDL password.

UDL Password is:  
1234

## 15. Configure Panel for Texcom Connect

1. Enter the engineers code  1  2  3  4

Yes to Select:-  
Zone Setup

2.

Press  7

YES to Select:-  
UDL/Digi Options

Press  /  Yes

UDL/Digi Options  
Reset Digi



Press **3**

UDL/Digi Options  
Program Digi

Press **✓**/**Yes** then **↕** to the ARC you wish to use.

For this example we will use ARC 1, but you can use any that are not already in use.

ARC 1 Protocol:  
Disabled

Press **X**/**No**

ARC 1 Protocol:  
> Disabled

Press **7** or use the **↕** to select the Texecom Connect Protocol.

ARC 1 Protocol:  
>Texecom Connect

Press **✓**/**Yes**

ARC 1 Protocol:  
Texecom Connect

Press **☰**/**Menu** 3 times then **✓**/**Yes**





**NOTE:** The panel will now make several changes to its programming populating all of the correct information to allow Texecom Connect to function properly.

The following items are automatically programmed. The IP address and port number for the primary and secondary Telephone numbers may differ from what is shown. This is normal as different ports are used for enhanced functionality such as time correction of the clock based on the country of installation.

- ARC Pri No.
- ARC Sec No.
- Dialing Attempts
- Report Areas
- Reports
- Config 1 (Protocol Options)
- Config 2 (Protocol Options 2)
- IP Polling Time

**V4 firmware has been changed and by default the following is applied:-**

Under UDL/Digi Options/Com Port Setup **Onboard Digi Com** is set to **Nothing Fitted**:

Under UDL/Digi Options/Digi Options **Enable Communicator** and **Dial All Numbers** are enabled by default:

## 16. Enable Texecom Connect App

Enter (1) (2) (3) (4)



Yes to Select:-  
Zone Setup

Press (7)



YES to Select:-  
UDL/Digi Options

Press (✓) / (Yes)



UDL/Digi Options  
Reset Digi



Press **4**

Enable Texecom  
Connect App?

\*This option will only appear when an ARC has the Texecom Connect Protocol enabled. If you don't see this screen please follow the previous steps and select Texecom Connect as the protocol for your chosen ARC.

Press  / 

The panel will now establish communication with the Connect Server. A successful call will result in an app code being generated and displayed on the keypad.

Texecom Connect  
App Code: XXXXXX

Write the code here:\*

--	--	--	--	--	--

Press  /  3 times then  / 

**\*NOTE:** The app code generated will only last for 60 minutes. If you do not use the code in this time-frame simply generate another one.

The Master User of the system can also generate an app code from the User menu on the keypad, OR in the Manage Users section of the app.

If you are likely to connect via Wintex remotely you will need an app code for a "First Time Setup" of the connection. The code may be provided to you by any of the methods detailed, and has the same lifespan.



## 17. Setting Up The Texecom Connect App

Open the Connect App on the device being used by the Master User of the system.

# Terms of Service

The Texecom Connect™, App allows you to arm, part arm, disarm and reset your alarm system.

These terms and conditions relate to the App and govern your use of the App with Texecom Limited (Us, Our, We, or Texecom).

The App currently only works on compatible devices running iOS 8 and above. We may change the version of the operating system the App works with at any time. Some features may not be available on all versions, visit our website at [www.texe.com](http://www.texe.com) for more information.

Sometimes we may allow or engage third parties to provide you with access to their services through the App. We are not responsible for providing these to you and you may be required to accept applicable terms and conditions provided by the third party. If these services are withdrawn, we may find alternatives where reasonably possible.

You may be charged by your service provider for internet access on your device.

APP TERMS AND CONDITIONS

I Accept

If you are happy with the Terms of Service, press I Accept



# Terms of Service

The Texecom Connect™, App allows you to arm, part arm, disarm and reset your alarm system.

These terms and conditions relate to the App and govern your use of the App with Texecom Limited (Us, Our, We, or Texecom).

The App currently only works on compatible devices running iOS 8 and above. We may

may be required to accept applicable terms and conditions provided by the third party. If these services are withdrawn, we may find alternatives where reasonably possible.

You may be charged by your service provider for internet access on your device.

APP TERMS AND CONDITIONS

I Accept

Wifi Network

Home Network Wifi network detected is this your home network?

Yes

No

APP TERMS AND CONDITIONS

I Accept

Confirm that the device is connected to the same network\* as the control panel press **Yes**

**NOTE:** If using a mobile device, providing it has an internet connection this step can still be completed. This dialogue box will only appear when the SmartCom is being used in WiFi mode.





Enter Your App Code

Done

1	2 ABC	3 DEF
4 GHI	5 JKL	6 MNO
7 PQRS	8 TUV	9 WXYZ
	0	

Enter the app code generated by the control panel.

Press **Submit**



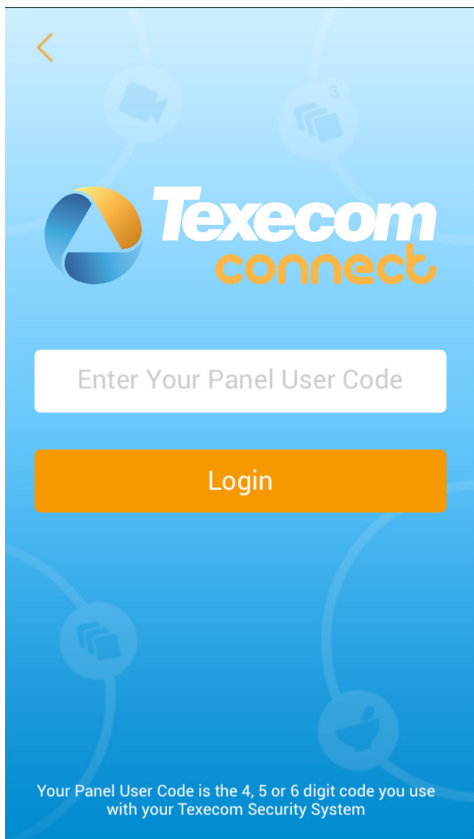

Enter the Master User code (default is 5678) for the Control panel





Choose whether to use fingerprint login or not.

\*This can be enabled at a later stage within the app if required.





Synchronising App  
with Security System



The app and the security system will now synchronise, this can take a few minutes so please be patient.







## App Sync Complete

Your Texecom Connect App is now synchronised with your Security System.

Your Texecom Connect App now needs to know what Device is mapped to each security zone. It also needs to know which Room in the property the Device is located.

The following screen provides an overview of how to map your Devices and Rooms before continuing

Continue

Follow the instructions on the screen and press **Continue**





On the next screen the Devices on your Security System will be displayed.

Selecting each Device will then present you with the option to select its type (Connect Devices will already have their types assigned). After this the Device needs to be assigned to a Room. New Rooms can be created by pressing the + button.

Once the Device type and Room has been assigned, it will change from blue to orange indicating which devices are left to assign. Once all of your devices are assigned to Rooms, simply press 'Confirm Devices' to save them.

Map Device Types & Rooms

Follow the instructions on the screen and **Map your Device Types & Rooms**



Zone Devices		
001	Front Door	>
002	Hallway	>
003	Lounge	>
004	Backdoor	>
009	Kitchen	>
010	Landing Smoke	>
011	Shed Door	>
<div style="background-color: #f9a825; border-radius: 10px; padding: 10px; text-align: center; width: fit-content; margin: 0 auto;">           Confirm Device Types         </div>		

All devices with Zone Text will be displayed.  
**NOTE:** If you do not see any devices listed check if the devices have zone text.



Device Type
Door Sensor
Movement Sensor
Shock Sensor
Glass Sensor
Smoke Sensor
Heat Sensor
Fire Sensor
CO Sensor
PA Button
Select the Device Type for this Zone

Choose the device type for wired devices.

*Ricochet* enabled devices will automatically select the correct device type.



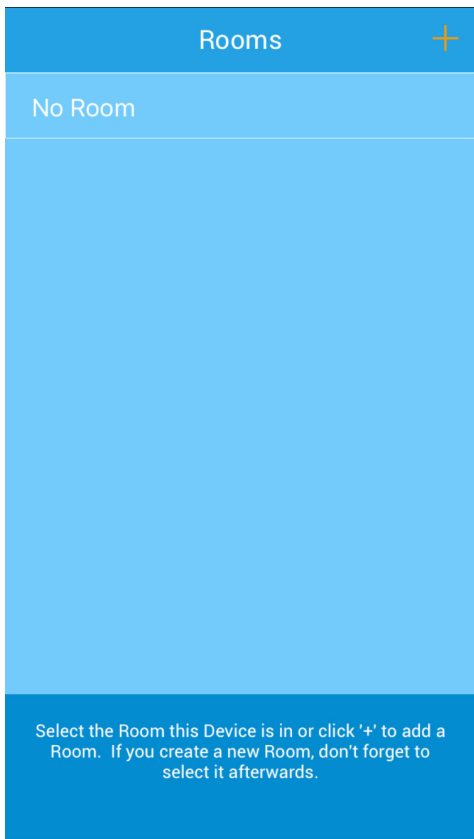

Select a room for the device, if the room isn't there **click +** and create it. Rooms may be edited at a later date.



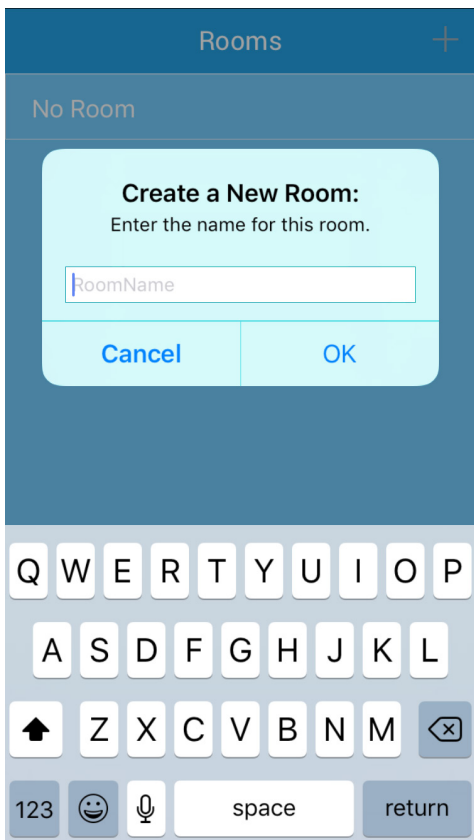

Name the room, don't forget to assign the device to the room! Click OK and then click on the room name to add the device.



Zone Devices		
001	Front Door	∨
	Door Sensor	
	Hallway	
002	Hallway	>
003	Lounge	>
004	Backdoor	>
009	Kitchen	>
010	Landing Smoke	>
011	Shed Door	>
<div>Confirm Device Types</div>		

Now do the same for the rest of the devices, creating new rooms as required.  
If you have created all your rooms you may choose from the existing list.



Zone Devices		
001	Front Door	∨
002	Hallway	∨
003	Lounge	∨
004	Backdoor	∨
009	Kitchen	∨
010	Landing Smoke	∨
011	Shed Door	∨

Confirm Device Types

Check all zones are highlighted in Orange, if not please assign all devices to rooms.  
Once complete press **Confirm Device Types**.







## Congratulations!

You have successfully created your rooms and assigned your devices to each room.

You have now completed your system configuration and you can start to use the Texecom Connect App.

Visit the App Menu to add more cameras, alter device types or manage your rooms.

[Start Using Your App](#)

Congratulations, your app is now ready for use.



## 18. Connect Devices

All Connect devices should be added to the system using the app **AFTER** all other *Ricochet* Enabled devices have been installed.

Instructions on adding and removing Connect devices can be found within the app in the Help & Guidance Section. Please follow these instructions.

Some points to note regarding the operation of ***Ricochet*** Enabled Connect devices:-

- Connect Devices must be added **AFTER** Security & Life Safety Devices
- Connect Devices **MUST** be added using the app
- Connect devices may not function if no other *Ricochet* devices are installed
- Texecom Connect SmartPlug range and signal may be affected by metal sockets
- Texecom Connect SmartPlug range and signal may be affected if blocked by furniture
- Texecom Connect SmartPlug may exhibit a 1 - 2 second delay if hopping through other devices.

## Flash Upgrading an Elite Panel

Connect to the control panel with Wintex using the ComUSB and save the profile.

- Remove power from the control panel and connect the Flash interface to the control panel and PC as shown:

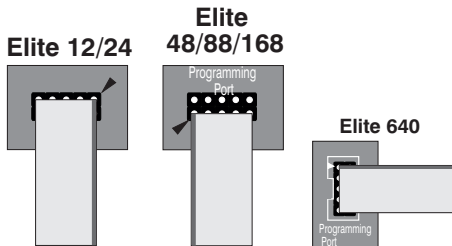

Connect 10-way header to Programming Port.  
Pin 1 (Red) to arrows on Control panel PCB as shown below

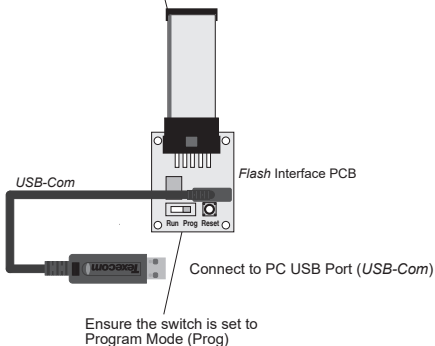

- Re-apply power to the control panel and press the RESET button on the Flash Interface board.
- Ensure that the Flash Interface is connected to the control panel and PC as shown previously.

**NOTE:** If you have anything connected to the control panel COM Ports , you MUST UNPLUG them.

- Run the Premier Elite Flasher software on the PC, the following screen will appear:

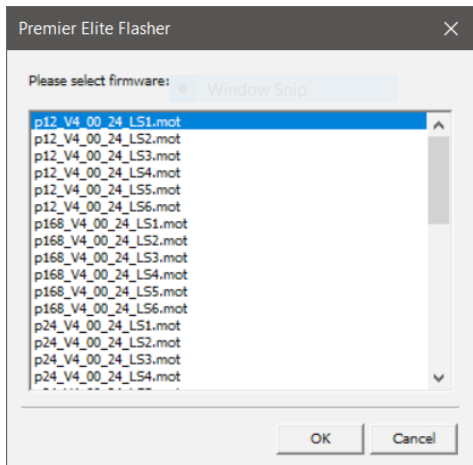

- Choose which panel and firmware version you wish to use. If the version number you wish to use is later than the one listed, just click on the correct panel type. You will be presented with the following screen.



- To change the firmware file being used click on select, you will be presented with the following screen

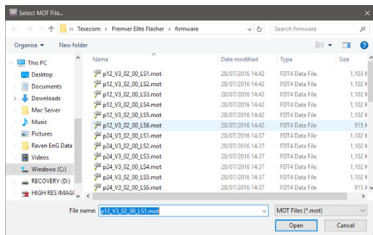

- Browse to file you want to use and click open.
- Click on Select Com Port, and enter the com port number that you're USB-Com is connected too; press OK

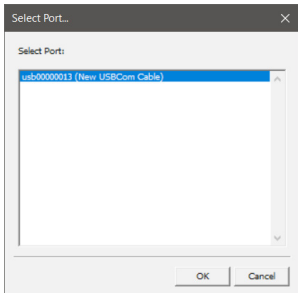

- Press the Flash Button the following screen will appear

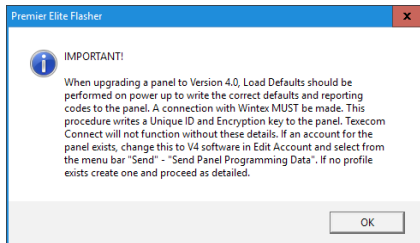

- Press OK

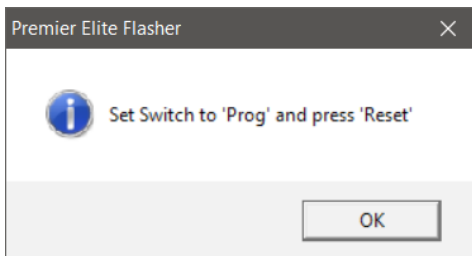

- Set the switch to "Prog" and press "Reset" on the flasher interface. Press OK



- When complete the following will appear

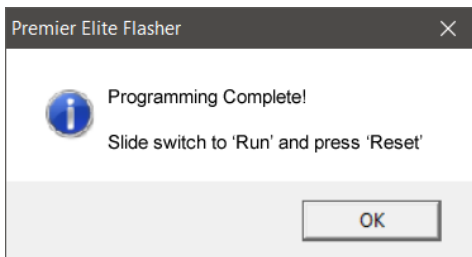

**Note:** When sending data back to the control panel after upgrading to V4 from Wintex please ensure the com port used is programmed as "Nothing Fitted".

## Power Up &amp; Initial Config - Flash Upgraded Panel

After flash upgrading the control panel and installing any additional wired devices, the system can be powered up.

It is critical that the defaults are loaded during the initial power up to ensure the control panel is loaded with the correct factory configuration.

- Locate the "Load Defaults" button and the "Heartbeat" LED on the PCB
- Press and hold the "Load defaults" button and apply power to the panel. Release the "Load Defaults" button when the "Heartbeat" LED starts flashing rapidly.

The Keypad display will look like this:

DEFAULTING NUM  
PLEASE WAIT...XX

Once complete the alarm will sound. Enter the default engineers code (1) (2) (3) (4) to silence the panel.

The Keypad will now scroll through various error messages. Enter (1) (2) (3) (4) again. The display will ask you to set the language for the system.

Do you want to  
Set Language?

Press (✓) / (Yes) the display will show:-

Language  
English -UK

Press (✓) / (Yes) or use the (↕) key to select a different language.

Press (✓) / (Yes) to confirm.

The keypad will show

Do you want to  
Default Wireless

Press (✓) / (Yes) to clear all wireless devices or Press (X) / (No) to continue.

Connected keypads and expanders need to be confirmed to the system. The display will show:-

Engineer Utils  
Confirm Devices

Press /Yes the display will show the number of keypads and expanders fitted.

Net RKP > 1.  
1 EXP > 1

Press /Yes the display will show

Press YES again  
to Confirm.

Press /Yes

- At this point if the system already has *Ricochet* enabled devices learned and a panel profile that is saved in Wintex, you can press /No and proceed to update the panel profile as detailed later.
- If you have any additional *Ricochet* enabled devices to be learned, and no saved panel profile follow the detail below.
- The Texecom Connect SmartPlug MUST be added to the system using the app once all other steps are complete.

The display will show

Learn Ricochet  
Enabled Devices?

Learn all of your devices (**Not SmartPlugs!**) And then place them in their final location and allow to commission for 15 minutes. Once learning is complete press /Menu and then **1** to program the Zones.

If there are no *Ricochet* enabled devices to learn press /Menu twice and then **1** to program the Zones.



## IMPORTANT FLASH UPGRADED PANELS

This step **MUST** be completed even if you do not have a saved profile for the panel. During this process a Unique ID code is written to the panel. Without this code Texcom Connect will not function. Wintex 6.2.5> is required.

- Open the account profile of the control panel that you have just flash updated.
  - If there is no profile, create one.

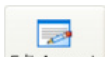

- Click on the "Edit Account" button
- Select the "Panel Details" tab:

A screenshot of the "Edit Account Details" dialog box. The "Panel Details" tab is selected. The form contains fields for Panel Type (Blte 12), Software Version (4.x), Serial Number (1001902), LDI Password (\*\*\*\*), Date Installed (05/04/2017), LCD Display Type (International), and Country (United Kingdom). There are also checkboxes for "Include Zone Text on Send/Receive", "Include All Zones on Send/Receive", "Include All Radio Config when Sending Data", and "Include All Roicost Config when Sending Data". On the right, there are fields for Panel Model Type (Orboard/Com300), Panel Model No., Radio-Pad N/A, Radio-Pad NSN (23533900), Radio-Pad ESN, Host Address, and Host Port. A "Connect via WebWayOne SMS" checkbox is at the bottom right. Buttons for "OK", "Cancel", and "help" are at the bottom.

- Click on the "Software Version" drop-down box and select the version that matches the version you used to flash the control panel.
- Click OK, Wintex will automatically update any new options to their default settings in the stored profile.



- Click on the "Connect" button to connect to the control panel using USB-Com.

**NOTE:** Once connection is established a Unique ID (GUID) will be sent to the panel.

- If you have programming data to send to the panel click on the send button at the top of the page, and select "Send Panel Programming Data"

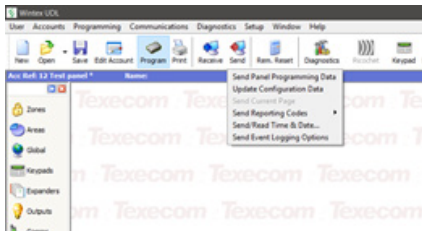

### Troubleshooting

#### When setting up the Smartcom Wi-Fi the SSID is not displayed.

- Ensure you are local to the Smartcom when setting up the Wi-Fi
- Press and hold the Wi-Fi button for 5 seconds so that the Wi-Fi LED is flashing slowly.
- Wait 30 seconds and then refresh your connection screen.
- Try using another device such as a mobile phone to see if the Smartcom SSID is displayed.

#### When doing a Connect Call the Incorrect Config message is displayed.

- Ensure a UDL password has been entered.
- Ensure that the panel has a GUID number under Engineer Utilities, Unique ID
- Ensure the comports are programmed correctly
- Log out of engineer mode, log back in and try the connect call again

#### When doing a Connect call I get the Call Failed message

- Check that you have a solid LED for the Wi-Fi or Ethernet connection. If the LED is flashing, please check the programming of the comports and ensure the router is enabled for DHCP addressing.
- If the Wi-Fi or Ethernet LED is solid, then check if the Cloud LED is solid. Please note that this can take several minutes to form a connection. If a connection is unsuccessful, please call Technical Support for more options.

#### When I enter the connect code into the App I get the message invalid code.

- The code has been used or expired. Please generate a new code from the panel by doing another Connect Call.

#### When I enter the User code into the App I get the message User not valid.

- Ensure that the Master user code is used and is correct.

#### When I try to learn a SmartPlug from the App I get the message No wireless slots available.

- Check that the panel has been fitted with a *Ricochet* 8XP-W, 32XP-W or on board receiver for -W panels.
- Ensure that there are free *Ricochet* slots available on the panel, a connect device will use a zone slot.

#### The plug will not learn on.

- Remove the SmartPlug from the socket, and hold the button for 1-2 seconds.
- Start the learning on the App and plug in when instructed to do so.
- Ensure the power is turned on at the socket.
- The green LED will flash to indicate it is learning.

**NOTE:** The Smartplug may need to hop through other *Ricochet* enabled devices depending on the location it is being installed in however it cannot learn without a direct connection to the *Ricochet* Receiver. In this case start the learning and plug in closer to the Receiver. Once learnt relocate and allow the mesh to rebuild automatically.

#### How do I enable notifications?

- Notifications are enabled by default. They can be turned off from within the App.

#### How do I enable Emails?

- Emails are setup for each user within the Manage User section of the App.

#### How do I turn on or off the finger print login?

- This is setup for each user within the Manage User section of the App.

#### The Zones are not displayed in the App.

- Ensure text has been assigned to all zones. Sync the App again once text has been added.

#### The Areas are not displayed in the App and notifications are missing my site name.

- Ensure text has been assigned to all required Areas. Sync the App again once text has been added.

#### The Users are not displayed in the App.

- Ensure text and a code has been assigned to all Users. Sync the App again once a code and text has been added.

#### Will I get notifications while I am connected using the Connect App?

- The Smartcom can sustain an active connection and send notifications for true two-way communication.

#### The timeline in the App is not correct.

- The timeline is built from the notifications you receive. Please check that notifications are enabled and that your phone is enabled for data.
- Ensure your phone has adequate signal for notifications to be received.

#### What do I do with the Radio Conf Fail message that is displayed on my keypad for a Connect device?

- Please ensure that the Connect device is plugged in and power has been applied. The fault will then clear from the keypad when the connection is restored with the panel.

**NOTE:** Radio Conf Fail has been displayed because a Recipe tried to activate the Connect device but was unable to do so.

## 22. Specifications

### Specifications

Alarm System	EN50131-1, PD6662, Grade 2 Class II
Product Type	CELA0000
Ethernet	10/100 Base-T, 100 Base-TX
WiFi Module	2.4Ghz IEEE802.11 (b/g/n)
Max RF Power	15 dbm - internal antenna
Operating Voltage	8 - 15V dc
Typical Current	150mA
Relative Humidity	0 - 95% non-condensing

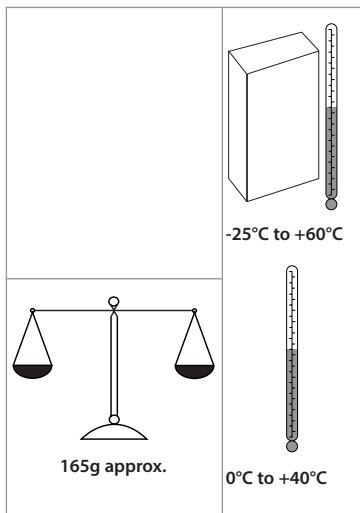
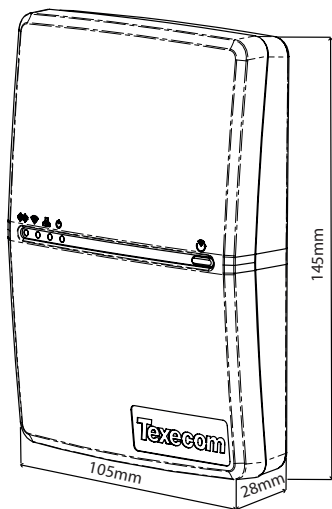

**Supplier:** Texecom Ltd, Haslingden, Lancashire, BB4 4PW, UK.

WEEE Directive: 2012/19/EC: Products marked with this symbol cannot be disposed of as unsorted municipal waste in the European Union. For proper recycling, return this product to your local supplier upon the purchase of equivalent new equipment, or dispose of it at designated collection points. For more information see: [www.recyclethis.info](http://www.recyclethis.info).

**Maintenance:** Test annually by the installer.

**Warranty** 2 year replacement warranty. As the Premier Elite SmartCom is not a complete alarm system, but only a part thereof, Texecom cannot accept responsibility or liability for any damages whatsoever based on a claim that the Premier Elite SmartCom failed to function correctly. Due to our policy of continuous improvement Texecom reserves the right to change specification without prior notice.

Herby, Texecom declares that the radio equipment Type:CELA0000 (Premier Elite SmartCom), is in conformity with Directive 2014/53/EU. The full EU declaration of conformity is available here:

<http://www.texecom.com/cert/doc/DEC-T00282.pdf>



MADE IN ENGLAND  
© 2017 Texecom Ltd  
[www.texecom.com](http://www.texecom.com)

**Cette instruction en français**



**Denne instruksjonen på norsk**



**Esta instrução em português**



**Ez az utasítás magyarul**



**Questa istruzione in italiano**



**Tento pokyn v češtině**



**Denne instruktion på dansk**



**Diese Anleitung auf Deutsch**



**Esta instrucción en español**



**Denna instruktion på svenska**

